

# 规格承认书 SPECIFICATION

编号(No): .....  
日期(Date): .....

客户 (Customer): .....

品名(Product Name): 片式NTC热敏电阻 Chip NTC thermistor .....

料号 ( Part Number ) : QN0805系列 QN0805 Series .....

客户规格(Customer's Part Number): .....

## QN0805系列规格书

### Specification for QN0805 Series

客户承认 CUSTOMER CONFIRM			
承认章 STAMP	核准 APPROVE	审核 CHECK	经办人 SIGNATURE

东莞市瑞迈电子科技有限公司

**Dongguan REOMAX Electronics Co., Ltd.**

1 外形尺寸 Shape and Dimensions

- 尺寸: 见图 1 和表 1
- PCB 焊盘: 见图 2 和表 1
- Dimensions: See Fig.1 and Table 1.
- Recommended PCB pattern for reflow soldering: See Fig.2 and Table 1



图 1 Fig.1



图 2 Fig.2

表 1 (Table 1)

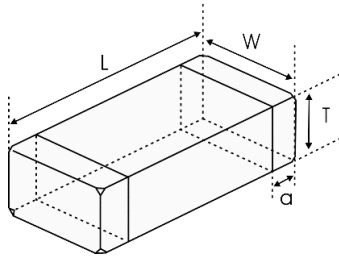
单位 unit: inch[mm]

类别 Type	L	W	T	a	A	B	C
0805 [2012]	0.079±0.008 [2.0±0.2]	0.049±0.008 [1.25±0.2]	0.033±0.008 [0.85±0.2]	0.020±0.012 [0.5±0.3]	[1.0-1.1]	[0.6-0.7]	[1.0-1.2]

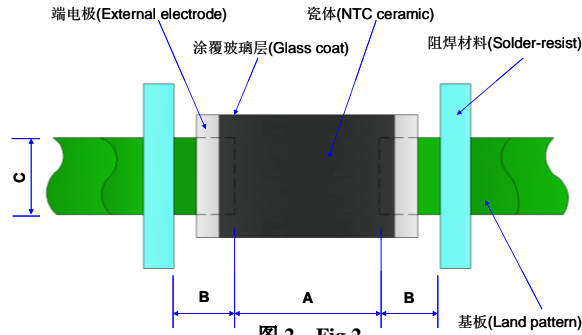
2 产品标识 (料号) Product Identification(Part Number)

QN   0805   X   104   F   4250   F   B  
 ①   ②   ③   ④   ⑤   ⑥   ⑦   ⑧

① 类别 Type	
QN	片式 NTC 热敏电阻器 Chip NTC Thermistor
② 外形尺寸(mm) External Dimensions (L×W×T)	
0201[0603]	0.60×0.30×0.30
0402[1005]	1.00×0.50×0.50
0603[1608]	1.60×0.80×0.80
0805[2012]	2.00×1.25×0.85
1206[3216]	3.20×1.60×0.85
③ 分隔符 Delimiter	
X	

④ 25℃的零功率电阻 Nominal Zero-Power Resistance at 25℃	
222	2.2kΩ
473	47kΩ
104	100kΩ

⑤ 电阻值公差 Tolerance of Resistance	
F	±1%
G	±2%
H	±3%
J	±5%

⑥ B 值常数 B Constant	
3435	3435K
3950	3950K
4250	4250K

⑦ B 值公差 Tolerance of B Constant	
F	±1%
H	±3%

⑧ B 值计算方式 B constant calculation method	
A	25℃&85℃
B	25℃&50℃

## 3 电气特性 Electrical Characteristics

## 1) F 档 F Series

型号 Part No	电阻值 Resistance (25℃) (kΩ)	B 常数 B Constant (25/50℃) (K)	B 常数 B Constant (25/85℃) (K)	允许工作电流 Permissible Operating Current (25℃) (mA)	耗散系数 Dissipation Factor (mW/℃)	热时间常数 Thermal Time Constant (s)	额定功率 Rated Electric Power(25℃) (mW)	工作温度 Operating ambient temperature (℃)
QN0805X103F3435FA	10±1%	3380±1%	3435±1%	0.44	1.0	<5	100	-40~+125
QN0805X103F3450FB	10±1%	3450±1%	3500	0.44				
QN0805X103F3950FB	10±1%	3950±1%	3987	0.44				
QN0805X223F3950FB	22±1%	3950±1%	3987	0.30				
QN0805X333F4050FB	33±1%	4050±1%	4100	0.24				
QN0805X473F4050FB	47±1%	4050±1%	4100	0.20				
QN0805X683F4150FB	68±1%	4150±1%	4210	0.16				
QN0805X104F3950FB	100±1%	3950±1%	3987	0.14				
QN0805X104F4250FB	100±1%	4250±1%	4310	0.14				

## 2) H 档 H Series

型号 Part No	电阻值 Resistance (25℃) (kΩ)	B 常数 B Constant (25/50℃) (K)	B 常数 B Constant (25/85℃) (K)	允许工作电流 Permissible Operating Current (25℃) (mA)	耗散系数 Dissipation Factor (mW/℃)	热时间常数 Thermal Time Constant (s)	额定功率 Rated Electric Power(25℃) (mW)	工作温度 Operating ambient temperature (℃)
QN0805X103H3435FA	10±3%	3380±1%	3435±1%	0.44	1.0	<5	100	-40~+125
QN0805X103H3450FB	10±3%	3450±1%	3500	0.44				
QN0805X103H3950FB	10±3%	3950±1%	3987	0.44				
QN0805X223H3950FB	22±3%	3950±1%	3987	0.30				
QN0805X333H4050FB	33±3%	4050±1%	4100	0.24				
QN0805X473H4050FB	47±3%	4050±1%	4100	0.20				
QN0805X683H4150FB	68±3%	4150±1%	4210	0.16				
QN0805X104H3950FB	100±3%	3950±1%	3987	0.14				
QN0805X104H4250FB	100±3%	4250±1%	4310	0.14				

## 3) J 档 J Series

型号 Part No	电阻值 Resistance (25℃) (kΩ)	B 常数 B Constant (25/50℃) (K)	B 常数 B Constant (25/85℃) (K)	允许工作电流 Permissible Operating Current (25℃) (mA)	耗散系数 Dissipation Factor (mW/℃)	热时间常数 Thermal Time Constant (s)	额定功率 Rated Electric Power(25℃) (mW)	工作温度 Operating ambient temperature (℃)
QN0805X103J3435FA	10±5%	3380±1%	3435±1%	0.44	1.0	<5	100	-40~+125
QN0805X103J3450FB	10±5%	3450±1%	3500	0.44				
QN0805X103J3950FB	10±5%	3950±1%	3987	0.44				
QN0805X223J3950FB	22±5%	3950±1%	3987	0.30				
QN0805X333J4050FB	33±5%	4050±1%	4100	0.24				
QN0805X473J4050FB	47±5%	4050±1%	4100	0.20				
QN0805X683J4150FB	68±5%	4150±1%	4210	0.16				
QN0805X104J3950FB	100±5%	3950±1%	3987	0.14				
QN0805X104J4250FB	100±5%	4250±1%	4310	0.14				
QN0805X154J4250FB	150±5%	4250±1%	4310	0.11				
QN0805X224J3950FB	220±5%	3950±1%	3987	0.08				
QN0805X334J3950FB	330±5%	3950±1%	3987	0.07				
QN0805X474J3950FB	470±5%	3950±1%	3987	0.05				

## 4 检验和测试程序

## ▪ 测试条件

如无特别规定，检验和测试的标准大气环境条件如下：

- 环境温度：20±15℃；
- 相对湿度：65±20%；
- 气压：86 kPa~106 kPa

如果对测试结果有异议，则在下述条件下测试：

- 环境温度：25±2℃；
- 相对湿度：65±5%
- 气压：86kPa ~ 106kPa

## ▪ 检查设备

外观检查：20 倍放大镜；  
阻值检查：热敏电阻测试仪

## 4 Test and Measurement Procedures

## ▪ Test Conditions

Unless otherwise specified, the standard atmospheric conditions for measurement/test as:

- Ambient Temperature: 20±15℃
- Relative Humidity: 65±20%
- Air Pressure: 86kPa to 106kPa

If any doubt on the results, measurements/tests should be made within the following limits:

- Ambient Temperature: 25±2℃
- Relative Humidity: 65±5%
- Air Pressure: 86kPa to 106kPa

## ▪ Inspection Equipment

Visual Examination: 20× magnifier  
Resistance value test: Thermistor resistance tester

## 5 电性测试 Electrical Test

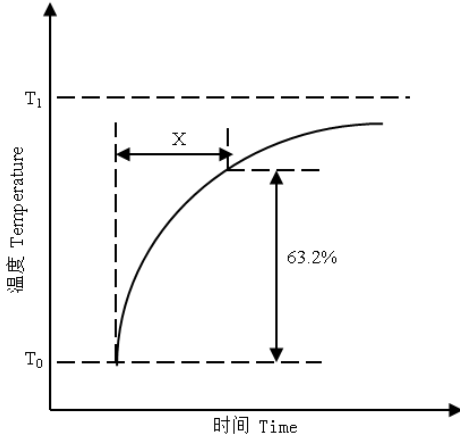
序号 No.	项目 Items	测试方法及备注 Test Methods and Remarks
1	25℃零功率电阻值 Nominal Zero-Power Resistance at 25℃(R25)	环境温度 Ambient temperature: 25±0.05℃ 测试功率 Measuring electric power: ≤0.1mW
2	B 值常数 Nominal B Constant	分别在环境温度 25±0.05℃, 50±0.05℃或 85±0.05℃下测量电阻值。 Measure the resistance at the ambient temperature of 25±0.05℃, 50±0.05℃ or 85±0.05℃. $B(25-50^{\circ}\text{C}) = \frac{\ln R_{25} - \ln R_{50}}{1/T_{25} - 1/T_{50}}$ $B(25-85^{\circ}\text{C}) = \frac{\ln R_{25} - \ln R_{85}}{1/T_{25} - 1/T_{85}}$ T: 绝对温度 (K) Absolute temperature (K)
3	热时间常数 Thermal Time Constant	在零功率条件下, 当热敏电阻的环境温度发生急剧变化时, 热敏电阻元件产生最初温度 T <sub>0</sub> 与最终温度 T <sub>1</sub> 两者温度差的 63.2% 的温度变化所需要的时间, 通常以秒(S)表示。 The total time for the temperature of the thermistor to change by 63.2% of the difference from ambient temperature T <sub>0</sub> (°C) to T <sub>1</sub> (°C) by the drastic change of the power applied to thermistor from Non-zero Power to Zero-Power state, normally expressed in second(S). 
4	耗散系数 Dissipation Factor	在一定环境温度下, NTC 热敏电阻通过自身发热使其温度升高 1℃时所需要的功率, 通常以 mW/℃表示。可由下面公式计算: The required power which makes the NTC thermistor body temperature raise 1℃ through self-heated, normally expressed in milliwatts per degree Celsius (mW/°C). It can be calculated by the following formula: $\delta = \frac{W}{T - T_0}$
5	额定功率 Rated Power	在环境温度 25℃下因自身发热使表面温度升高 100℃所需要的功率。 The necessary electric power makes thermistor's temperature rise 100℃ by self-heating at ambient temperature 25℃.
6	允许工作电流 Permissible operating current	在静止空气中通过自身发热使其升温为 1℃的电流。 The current that keep body temperature of chip NTC on the PC board in still air rising 1℃ by self-heating.

6 信赖性试验 Reliability Test

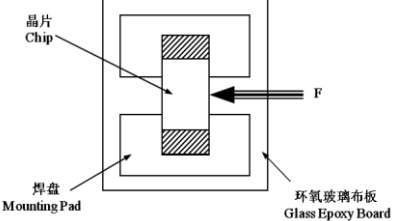
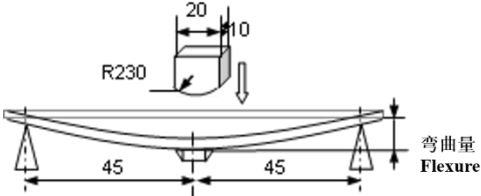
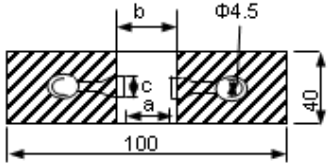
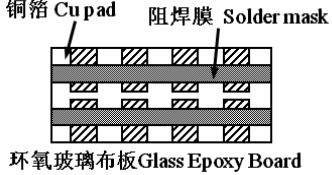
项目 Items	测试标准 Standard	测试方法及备注 Test Methods and Remarks	要求 Requirements																														
端头附着力 Terminal Strength	IEC 60068-2-21	<p>将晶片焊接在测试基板上（如右图所示的环氧玻璃布板），按箭头所示方向施加作用力； Solder the chip to the testing jig (glass epoxy board shown in the right) using eutectic solder. Then apply a force in the direction of the arrow.</p> <table border="1" data-bbox="496 450 1034 580"> <thead> <tr> <th>尺寸 Size</th> <th>F</th> <th>保持时间 Duration</th> </tr> </thead> <tbody> <tr> <td>0201, 0402, 0603</td> <td>5N</td> <td rowspan="2">10±1s</td> </tr> <tr> <td>0805</td> <td>10N</td> </tr> </tbody> </table>	尺寸 Size	F	保持时间 Duration	0201, 0402, 0603	5N	10±1s	0805	10N	<p>端电极无脱落且瓷体无损伤。 No removal or split of the termination or other defects shall occur.</p> 																						
尺寸 Size	F	保持时间 Duration																															
0201, 0402, 0603	5N	10±1s																															
0805	10N																																
抗弯强度 Resistance to Flexure	IEC 60068-2-21	<p>将晶片焊接在测试基板上（如右图所示的环氧玻璃布板），按下图箭头所示方向施加作用力； Solder the chip to the test jig (glass epoxy board shown in the right) using a eutectic solder. Then apply a force in the direction shown as follow;</p>  <table border="1" data-bbox="448 1133 1086 1352"> <thead> <tr> <th>尺寸 Size</th> <th>弯曲变形量 Flexure</th> <th>施压速度 Pressurizing Speed</th> <th>保持时间 Duration</th> </tr> </thead> <tbody> <tr> <td>0201,</td> <td>1mm</td> <td rowspan="2">&lt;0.5mm/s</td> <td rowspan="2">10±1s</td> </tr> <tr> <td>0402, 0603, 0805</td> <td>2mm</td> </tr> </tbody> </table>	尺寸 Size	弯曲变形量 Flexure	施压速度 Pressurizing Speed	保持时间 Duration	0201,	1mm	<0.5mm/s	10±1s	0402, 0603, 0805	2mm	<p>① 无外观损伤。 No visible damage. ② <math> \Delta R_{25}/R_{25}  \leq 5\%</math></p> <p>单位 unit: mm</p> <table border="1" data-bbox="1155 887 1517 1095"> <thead> <tr> <th>类型 Type</th> <th>a</th> <th>b</th> <th>c</th> </tr> </thead> <tbody> <tr> <td>0201</td> <td>0.25</td> <td>0.3</td> <td>0.3</td> </tr> <tr> <td>0402</td> <td>0.4</td> <td>1.5</td> <td>0.5</td> </tr> <tr> <td>0603</td> <td>1.0</td> <td>3.0</td> <td>1.2</td> </tr> <tr> <td>0805</td> <td>1.2</td> <td>4.0</td> <td>1.65</td> </tr> </tbody> </table> 	类型 Type	a	b	c	0201	0.25	0.3	0.3	0402	0.4	1.5	0.5	0603	1.0	3.0	1.2	0805	1.2	4.0	1.65
尺寸 Size	弯曲变形量 Flexure	施压速度 Pressurizing Speed	保持时间 Duration																														
0201,	1mm	<0.5mm/s	10±1s																														
0402, 0603, 0805	2mm																																
类型 Type	a	b	c																														
0201	0.25	0.3	0.3																														
0402	0.4	1.5	0.5																														
0603	1.0	3.0	1.2																														
0805	1.2	4.0	1.65																														
振动 Vibration	IEC 60068-2-80	<p>① 将晶片焊接在测试基板上（如右图所示的环氧玻璃布板）； Solder the chip to the testing jig (glass epoxy board shown in the left) using eutectic solder. ② 晶片以全振幅为 1.5mm 进行振动，频率范围为 10Hz ~55 Hz； The chip shall be subjected to a simple harmonic motion having total amplitude of 1.5mm, the frequency being varied uniformly between the approximate limits of 10 and 55 Hz. ③ 振动频率按 10Hz→55Hz→10Hz 循环，周期为 1 分钟，在空间三个互相垂直的方向上各振动 2 小时（共 6 小时）。 The frequency ranges from 10 to 55 Hz and return to 10 Hz shall be traversed in approximately 1 minute. This motion shall be applied for a period of 2 hours in each 3 mutually perpendicular directions (total of 6 hours).</p>	<p>无外观损伤。 No visible damage.</p> 																														
坠落 Dropping	IEC 60068-2-32	<p>从 1m 的高度让晶片自由坠落至水泥地面 10 次。 Drop a chip 10 times on a concrete floor from a height of 1 meter.</p>	<p>无外观损伤。 No visible damage.</p>																														

可焊性 Solderability	IEC 60068-2-58	① 焊接温度 Solder temperature: 245±5℃. ② 浸渍时间 Duration: 3±0.3s. ③ 焊锡成分 Solder: Sn/3.0Ag/0.5Cu. ④ 助焊剂 Flux: (重量比) 25%松香和 75%酒精 25% Resin and 75% ethanol in weight.	① 无外观损伤; No visible damage. ② 元件端电极的焊锡覆盖率不小于 95%。 Wetting shall exceed 95% coverage.															
耐焊性 Resistance to Soldering Heat	IEC 60068-2-58	① 焊接温度 Solder temperature: 260±5℃. ② 浸渍时间 Duration: 10±1s. ③ 焊锡成分 Solder: Sn/3.0Ag/0.5Cu. ④ 助焊剂 Flux: (重量比) 25%松香和 75%酒精 25% Resin and 75% ethanol in weight. ⑤ 试验后标准条件下放置 1~2 小时后测量。 The chip shall be stabilized at normal condition for 1~2 hours before measuring.	① 无外观损伤; No visible damage. ② $ \Delta R_{25}/R_{25}  \leq 5\%$ ③ $ \Delta B/B  \leq 2\%$															
温度周期 Temperature cycling	IEC 60068-2-14	① 无负载于下表所示的环境条件下重复 5 次。 5 cycles of following sequence without loading. <table border="1" data-bbox="491 801 1040 994"> <thead> <tr> <th>步骤 Step</th> <th>温度 Temperature</th> <th>时间 Time</th> </tr> </thead> <tbody> <tr> <td>1</td> <td>-40±5℃</td> <td>30±3min</td> </tr> <tr> <td>2</td> <td>25±2℃</td> <td>5±3min</td> </tr> <tr> <td>3</td> <td>125±2℃</td> <td>30±3min</td> </tr> <tr> <td>4</td> <td>25±2℃</td> <td>5±3min</td> </tr> </tbody> </table> ② 试验后标准条件下放置 1~2 小时后测量。 The chip shall be stabilized at normal condition for 1~2 hours before measuring.	步骤 Step	温度 Temperature	时间 Time	1	-40±5℃	30±3min	2	25±2℃	5±3min	3	125±2℃	30±3min	4	25±2℃	5±3min	① 无外观损伤; No visible damage. ② $ \Delta R_{25}/R_{25}  \leq 3\%$ ③ $ \Delta B/B  \leq 2\%$
步骤 Step	温度 Temperature	时间 Time																
1	-40±5℃	30±3min																
2	25±2℃	5±3min																
3	125±2℃	30±3min																
4	25±2℃	5±3min																
高温存放 Resistance to dry heat	IEC 60068-2-2	① 在 125±5℃空气中, 无负载放置 1000±24 小时。 125±5℃ in air, for 1000±24 hours without loading. ② 试验后标准条件下放置 1~2 小时后测量。 The chip shall be stabilized at normal condition for 1~2 hours before measuring.	① 无外观损伤; No visible damage. ② $ \Delta R_{25}/R_{25}  \leq 5\%$ ③ $ \Delta B/B  \leq 2\%$															
低温存放 Resistance to cold	IEC 60068-2-1	① 在 -40±3℃空气中, 无负载放置 1000±24 小时。 -40±3℃ in air, for 1000±24 hours without loading. ② 试验后标准条件下放置 1~2 小时后测量。 The chip shall be stabilized at normal condition for 1~2 hours before measuring.	① 无外观损伤; No visible damage. ② $ \Delta R_{25}/R_{25}  \leq 5\%$ ③ $ \Delta B/B  \leq 2\%$															
湿热存放 Resistance to damp heat	IEC 60068-2-78	① 在 40±2℃, 相对湿度 90~95%空气中, 无负载放置 1000±24 小时。 40±2℃, 90~95%RH in air, for 1000±24 hours without loading. ② 试验后标准条件下放置 1~2 小时后测量。 The chip shall be stabilized at normal condition for 1~2 hours before measuring.	① 无外观损伤; No visible damage. ② $ \Delta R_{25}/R_{25}  \leq 3\%$ ③ $ \Delta B/B  \leq 2\%$															
高温负荷 Resistance to high temperature load	IEC 60539-1 5.25.4	① 在 85±2℃空气中, 施加允许工作电流 1000±48 小时。 85±2℃ in air with permissive operating current for 1000±48 hours ② 试验后标准条件下放置 1~2 小时后测量。 The chip shall be stabilized at normal condition for 1~2 hours before measuring.	① 无外观损伤; No visible damage. ② $ \Delta R_{25}/R_{25}  \leq 5\%$ ③ $ \Delta B/B  \leq 2\%$															

7 编带 Taping

类型 Type	0805
编带厚度 Tape thickness(mm)	0.85±0.2
编带材质 Tape material	纸带 Paper Tape
每盘数量 Quantity per Reel	4K

(1) 编带图 Taping Drawings

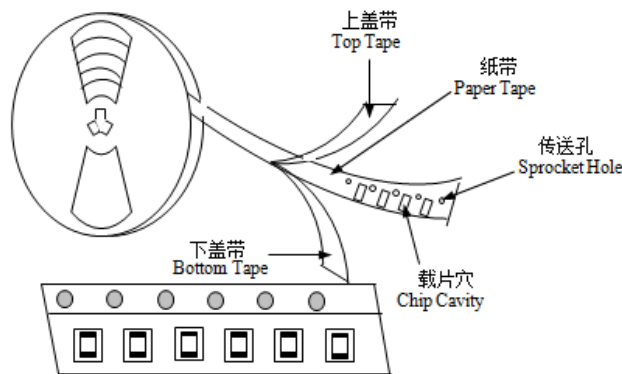

(2) 纸带尺寸 Paper Tape Dimensions (单位 Unit: mm)

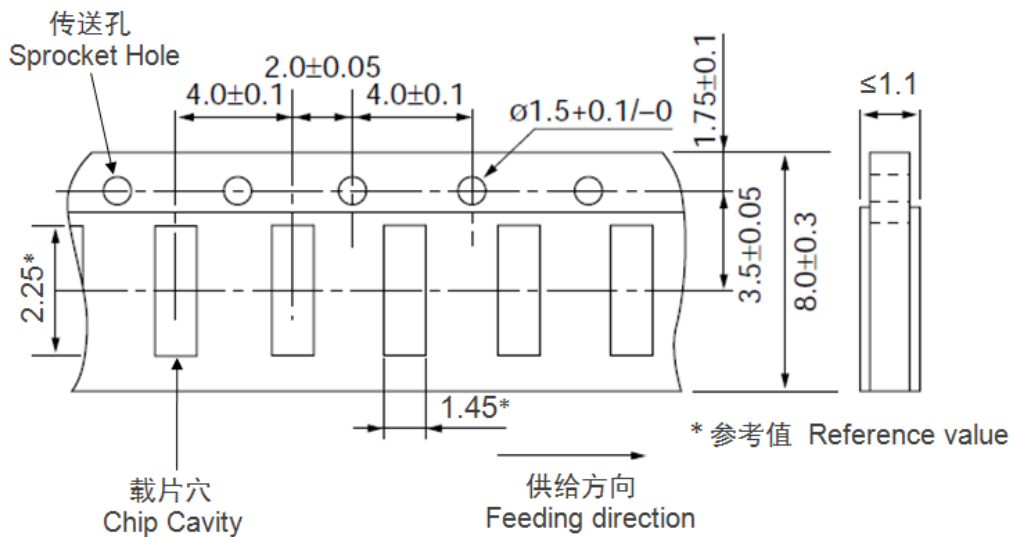

## (3) 卷盘尺寸 Reel Dimensions(单位 Unit: mm)

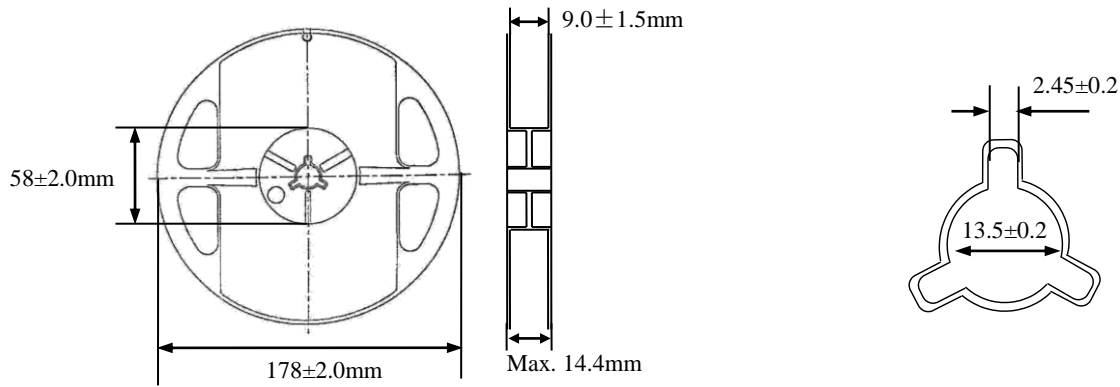
**8 储存**• **储存条件**

- a. 储存温度:  $-10^{\circ}\text{C} \sim 40^{\circ}\text{C}$
- b. 相对湿度:  $\leq 75\% \text{RH}$
- c. 避免接触粉尘、腐蚀性气氛和阳光

• **储存期限: 6 个月****9 注意事项**

## • QN 系列热敏电阻不可在以下条件下工作或储存:

- (1) 腐蚀性气体或还原性气体  
(氯气、硫化氢气体、氨气、硫酸气体、一氧化氮等)。
- (2) 挥发性或易燃性气体
- (3) 多尘条件
- (4) 高压或低压条件
- (5) 潮湿场所
- (6) 存在盐水、油、化学液体或有机溶剂的场所
- (7) 强烈振动
- (8) 存在类似有害条件的其他场所

## • QN 系列热敏电阻的陶瓷属于易碎材料, 使用时不可施加过大压力或冲击。

## • QN 系列热敏电阻不可在超过目录规定的温度范围情况下工作。

**8 Storage**• **Storage Conditions**

- a. Storage Temperature:  $-10^{\circ}\text{C} \sim 40^{\circ}\text{C}$
- b. Relative Humidity:  $\leq 75\% \text{RH}$
- c. Keep away from corrosive atmosphere and sunlight.

• **Period of Storage: 6 Months****9 Notes & Warnings**

## • The QN series thermistors shall not be operated and stored under the following environmental condition:

- (1) Corrosive or deoxidized atmospheres  
(such as chlorine, sulfurated hydrogen, ammonia, sulfuric acid, nitric oxide and so on)
- (2) Volatile or inflammable atmospheres
- (3) Dusty condition
- (4) Excessively high or low pressure condition
- (5) Humid site
- (6) Places with brine, oil, chemical liquid or organic solvent
- (7) Intense vibration
- (8) Places with analogously deleterious conditions

## • The ceramic body of the QN series thermistors is fragile, no excessive pressure or impact shall be exerted on it.

## • The QN series thermistors shall not be operated beyond the specified "Operating Temperature Range" in the catalog.

10 建议焊接条件

• 回流焊

- 温升 1~2°C/sec.
- 预热：150~170°C/90±30 sec.
- 大于 240°C 时间：20~40sec
- 峰值温度：最高 260°C/10 sec.
- 焊锡：Sn/3.0Ag/0.5Cu
- 回流焊：最多 2 次

10 Recommended Soldering Technologies

• Re-flowing Profile

- 1~2°C/sec. Ramp
- Pre-heating: 150~170°C/90±30 sec.
- Time above 240°C: 20~40 sec.
- Peak temperature: 260°C Max./10 sec.
- Solder paste: Sn/3.0Ag/0.5Cu
- Max.2 times for re-flowing

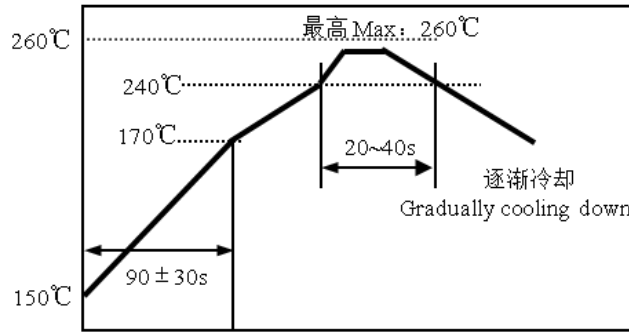

• 手工焊

- 烙铁功率：最大 20W
- 预热：150°C/60sec.
- 烙铁头温度：最高 280°C
- 焊接时间：最多 3sec.
- 焊锡：Sn/3.0Ag/0.5Cu
- 手工焊：最多 1 次

• Iron Soldering Profile

- Iron soldering power: Max.20W
- Pre-heating: 150°C/60sec.
- Soldering Tip temperature: 280°C Max.
- Soldering time: 3 sec Max.
- Solder paste: Sn/3.0Ag/0.5Cu
- Max.1 times for iron soldering

[注：不要使烙铁头接触到端头]

[Note: Take care not to apply the tip of the soldering iron to the terminal electrodes.]

