

RoHS

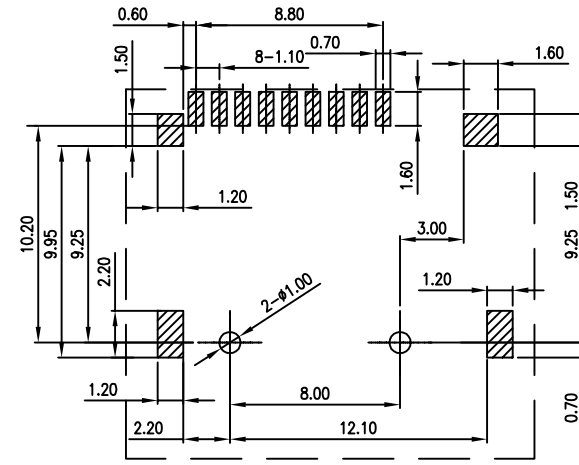
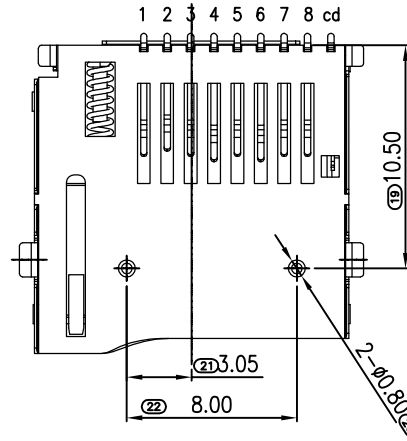
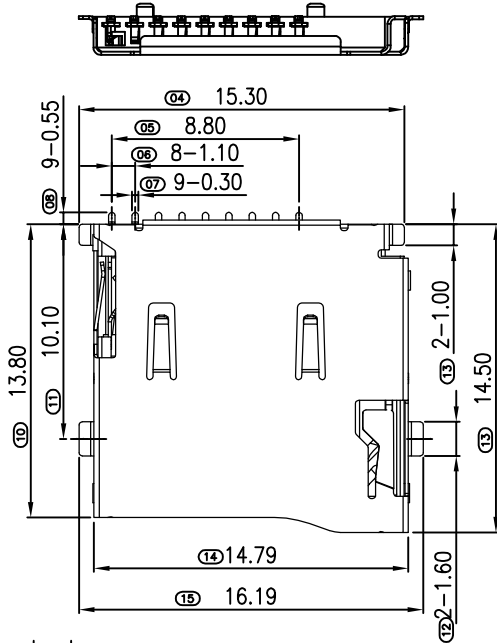
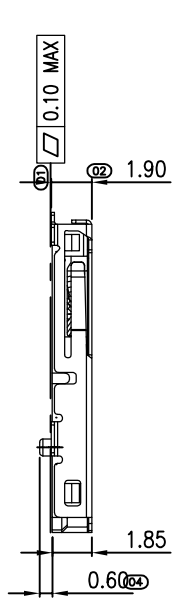

(RECOMMENDED/P.C.B)HOLE LAYOUT
COMPONENT SIDE VIEW TOLERANCE:±0.05

规格说明:

- 尺寸测量:
- 1-1. "▲" 为重点检验尺寸;
- 电气特性:
- 2-1. 额定接触电流: 0.5A Max;
- 2-2. 接触电阻: 100 mΩ Max;
- 2-3. 绝缘电阻: 1000MΩ MIN. 500V DC 测试时长1分钟.
- 机械特性:
- 3-1. 锁退卡耐久: 5000 cycles;
- 3-2. 锁卡力: 40N MAX;
- 3-3. 退卡力: 1.0N Min.
- 环境特性:
- 4-1. 测试温度范围: -25 °C to +85 °C;
- 4-2. 盐雾测试: 5% 浓度盐水 端子镀锡区域喷雾8H、刷金区域喷雾24H、外壳喷雾24H.

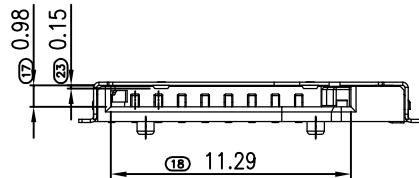
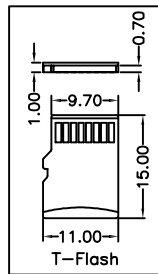

NO.	ASSIGNMENT
1#	DAT2
2#	CD/DAT3 ²
3#	CMD
4#	VDD
9#	CD
5#	CLK
6#	VSS
7#	DATO
8#	DAT1

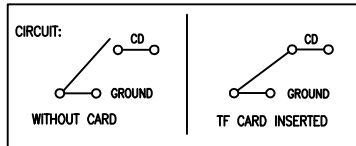

No.	品名	规格	数量
6	外壳	STAINLESS STEEL T=0.15mm 镀镍底30u 下压双压片平脚	1PCS
5	拉杆	STAINLESS STEEL 去磁	1PCS
4	滑块	LCP BLACK UL94 V-0	1PCS
3	弹簧	PIANO WIRE	1PCS
2	端子	COPPER ALLOY T=0.15mm 电镀镍底30u 镀雾锡80u 接触区域镀金0.5u	1PCS
1	主体	LCP BLACK UL94 V-0	1PCS

MILLIMETERS	INCH
X° ± 2°	X° ± 2°
.X ± 0.30	.XX ± 0.012
.XX ± 0.20	.XXX ± 0.008
.XXX ± 0.10	.XXXX ± 0.004

THESE DRAWINGS AND SPECIFICATIONS ARE THE PROPERTY OF CIXI CARDCONN ELECTRONIC CO.,LTD. COPIED OR USED IN ANY MANNER WITHOUT THE PRIOR WRITTEN CONSENT OF CIXI CARDCONN ELECTRONIC CO.,LTD

UNITS	MM
MAT'L	
SEE NOTES	
FINISH	
SEE NOTES	
QTY	
SEE NOTES	



慈溪市卡连电子有限公司
CIXI CARDCONN ELECTRONIC CO., LTD

PART NUMBER:
SCC100179620

TITLE:
TF 卡座 外焊9Pin 贴片式 下压双压片平脚锁键

APPD:

DWG NO.:
SCC-100179620

CHKD:

SCALE SHEET REV.
1:1 1/2 A0

DR:

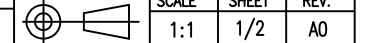

RoHS

← 包装方向 客户使用方向 →

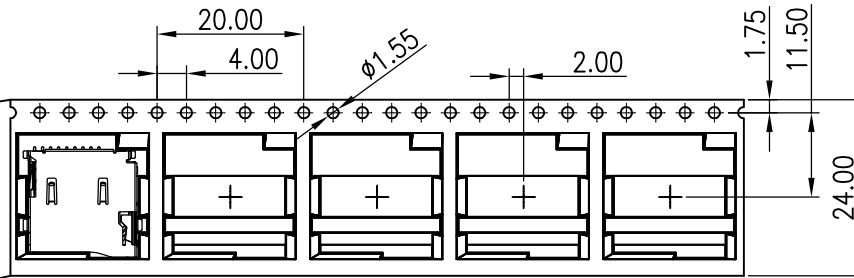

NOTES

1. 每卷包装数量:1000PCS/每卷
2. 卷带包装方式:

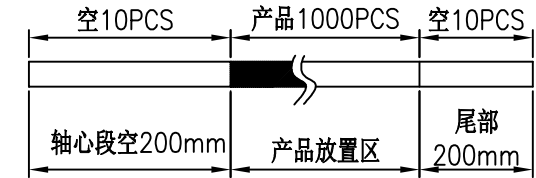

3. 每箱包装数量:10000PCS/箱

4. 重量 :
 - 4.1 净重 : Kg
 - 4.2 毛重 : Kg

盖带剥离角度:165°~180°
剥离力:20~130g

载带

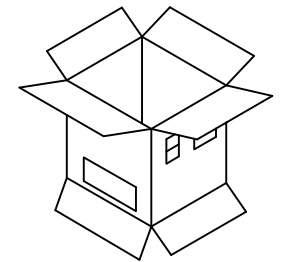
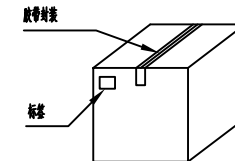
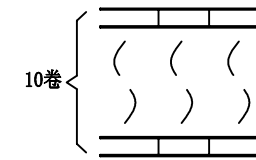
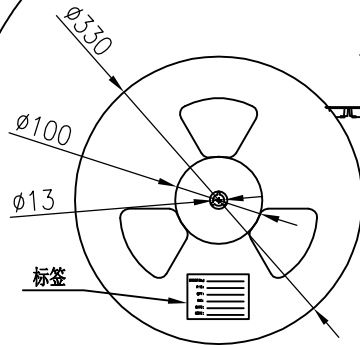

MILLIMETERS	INCH	UNITS	慈溪市卡连电子有限公司 CIXI CARDCONN ELECTRONIC CO.,LTD		
X° ± 2'	X° ± 2'	MM	PART NUMBER: SCC100179620	TITLE: TF 卡座 外焊9Pin 贴片式 下压双压片平脚镀镍	
.X ± 0.30	.XX ± 0.012	MAT'L		APPD:	DWG NO.:
.XX ± 0.20	.XXX ± 0.008	SEE NOTES	CHKD:	SCC-100179620	SCALE
.XXX ± 0.10	.XXXX ± 0.004	FINISH	DR:	1:1	SHEET
THESE DRAWINGS AND SPECIFICATIONS ARE THE PROPERTY OF CIXI CARDCONN ELECTRONIC CO.,LTD. COPIED OR USED IN ANY MANNER WITHOUT THE PRIOR WRITTEN CONSENT OF CIXI CARDCONN ELECTRONIC CO.,LTD			QTY	2/2	REV.
			SEE NOTES	A0	