

REV	CONTENT	CHK	DATE
VO.0	CONTENT	MYZ	21.07.06

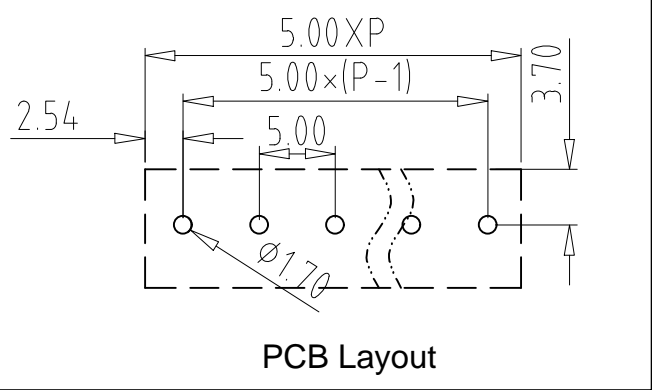

PCB Layout

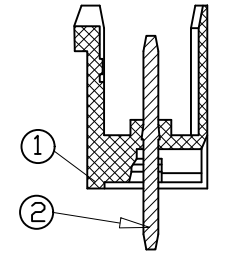

SECTION A-A

Electrical :

- | | | |
|--|---------------|------|
| | UL | IEC |
| 1. Rated Voltage : | 300V | 320V |
| 2. Rated Current : | 15A | 20A |
| 3. Withstanding Voltage : | AC1600V/1Min. | |
| 4. Operating Temperature : | -40°C~+105°C | |
| 5. RoHS Compliance | | |
| 6. Safty Approval : | | |
| 7. " ★ " is the key quality control point. | | |

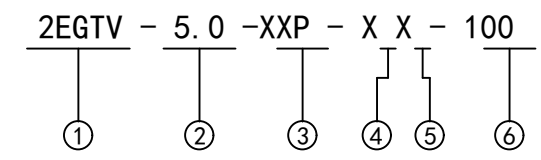
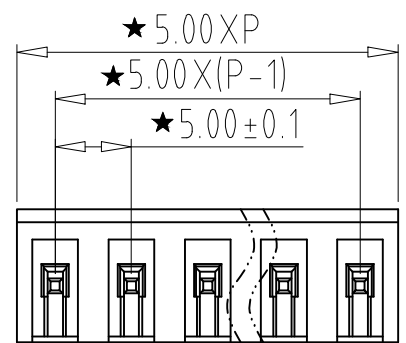
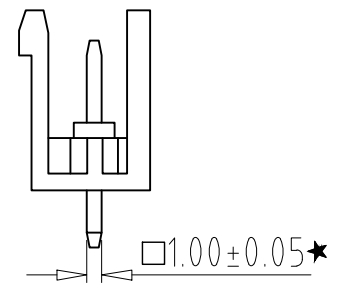
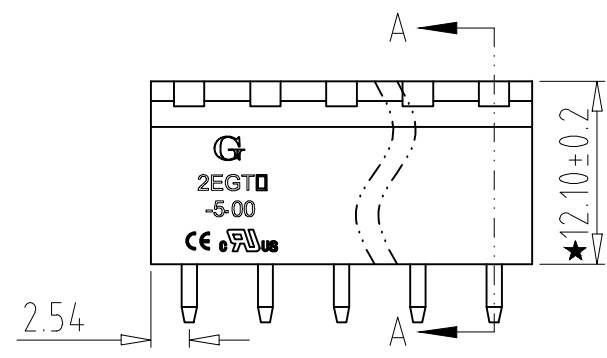
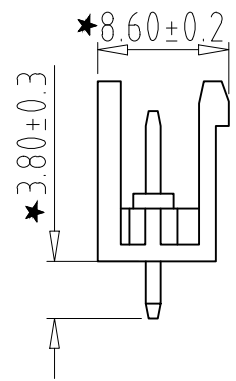

- ① Series No.
- ② Pitch
- ③ Poles
02 02Contacts
03 03Contacts
...
24 24Contacts
- ④ 1 Single Pitch
2 Double Pitch
- ⑤ Color: 1 Grey
2 Blue
3 Black
4 Green
5 Orange
6 Red
7 Transparent
8 Yellow
9 White
- ⑥ Customer Request: 100--Standard

Total Pitch Tolerances in mm									Nominal dimension range in mm										⊥	=	-	//						
over	over	over	over	over	over	over	over	over	over	over	over	over	over	over	over	over	over	over	over	over	over	over	over	over	over	over	over	over
0	30	53	70	90	115	150	250	350	0	30	53	70	90	115	150	200	250	320	10	10	all	10	0	100	150	0	100	150
±0.18	±0.20	±0.25	±0.3	±0.35	±0.44	±0.60	±0.70	±0.85	±0.20	±0.25	±0.30	±0.35	±0.44	±0.55	±0.70	±0.80	±0.90	0.2	0.3	0.3	0.3	0.2	0.2	0.3	0.5	0.2	0.3	0.5

2	PIN	XX	P	BRASS	Tin Plated
1	HOUSING	XX	1	PA66 UL94V-0	SEE NOTE
ITEM	NAME OF PART	NO. OF PART	Q'TY	MATERIAL	NOTE
DWG.	MYZ	DATE	21.07.06	SIZE	A4 UNITS mm SHEET/OF 1 / 1
CHK.	DATE		SCALE	1:1	
APP.	DATE				
			NAME	2EGTV-5.0-XXP-XX-100	
			DWGNO.	XXXXX	